

CEILING

$8\ 1/4"$

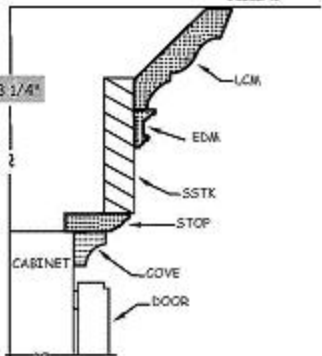

CEILING

$7\ 1/2"$

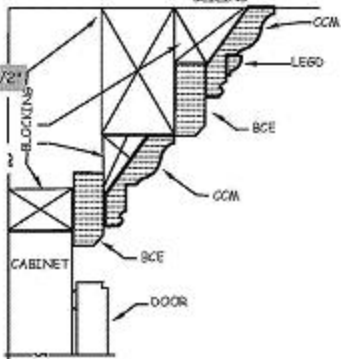

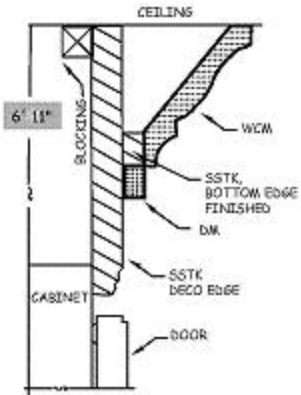

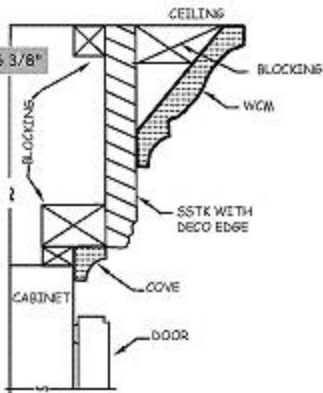
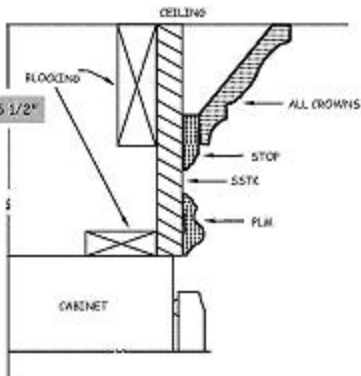

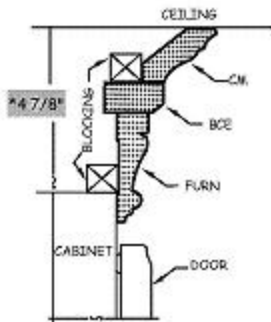
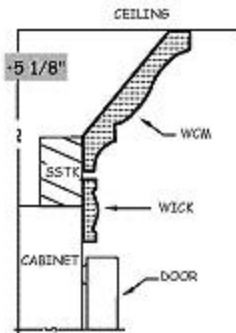
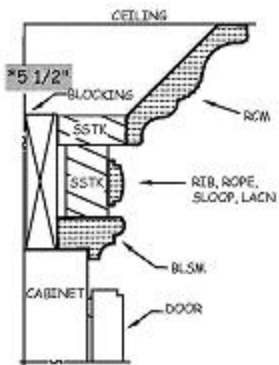
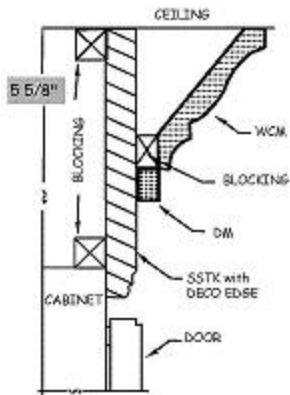

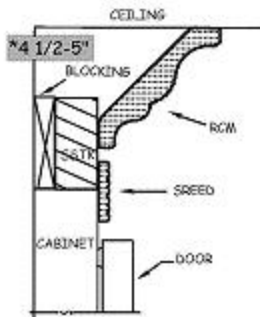
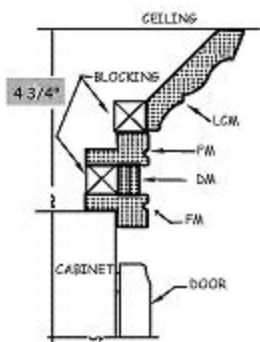
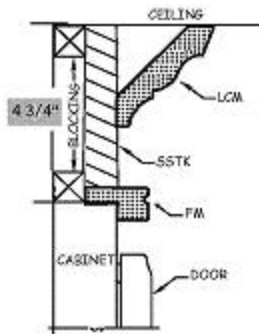

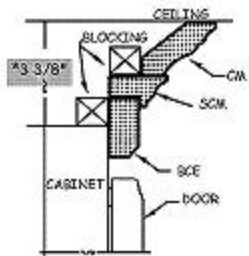
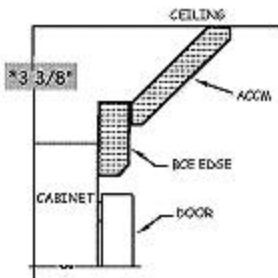
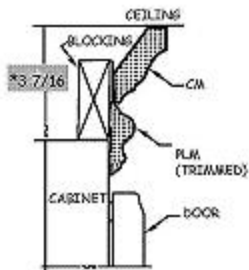
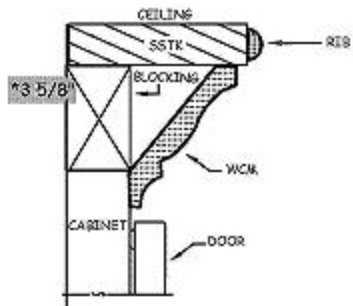

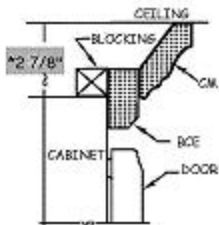
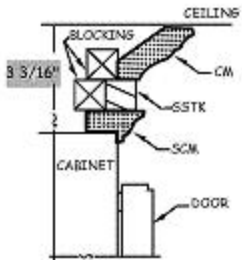
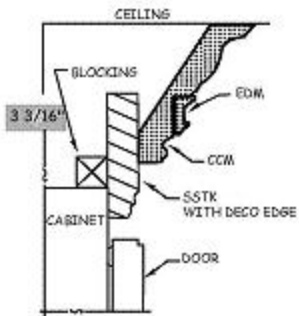

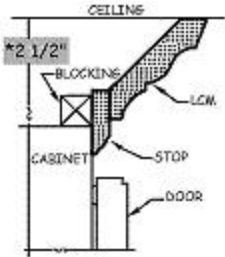

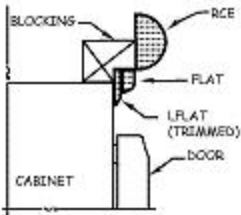
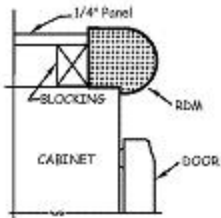

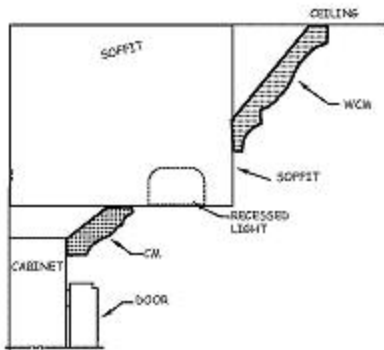
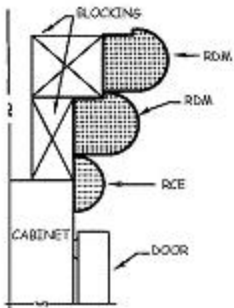

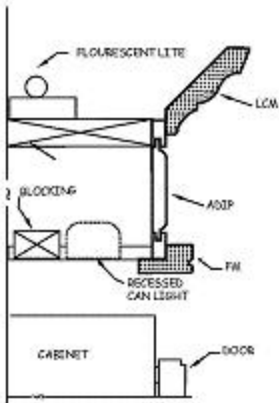

When this moulding application is used at the top of wall cabinets, the moulding creates display space above the cabinetry.

